

Preparation

**Part Number: PT420-74150**

**Kit Contents**

Item #	Quantity Req'd.	Description
1	1	Owner's Portfolio
2		
3		

**Hardware Bag Contents**

Item #	Quantity Req'd.	Description
1		
2		
3		

**Additional Items Required For Installation**

Item #	Quantity Req'd.	Description
1		
2		
3		

**Conflicts**

--

**Recommended Tools**

<b>Personal &amp; Vehicle Protection</b>	<b>Notes</b>
None	
<b>Special Tools</b>	<b>Notes</b>
None	
<b>Installation Tools</b>	<b>Notes</b>
None	
<b>Special Chemicals</b>	<b>Notes</b>
None	

**General Applicability**

2011+ xB/tC 2013+ FR-S 2016+ iA/iM
--

**Recommended Sequence of Application**







Item #	Accessory
1	
2	
3	

\*Mandatory

**Vehicle Service Parts** (may be required for reassembly)

Item #	Quantity Req'd.	Description
1		
2		
3		

**Legend**

	<b>STOP:</b> Damage to the vehicle may occur. Do not proceed until process has been complied with.
	<b>OPERATOR SAFETY:</b> Use caution to avoid risk of injury.
	<b>CAUTION:</b> A process that must be carefully observed in order to reduce the risk of damage to the accessory/vehicle and to ensure a quality installation.
	<b>TOOLS &amp; EQUIPMENT:</b> Used in Figures calls out the specific tools and equipment recommended for this process.
	<b>REVISION MARK:</b> This mark highlights a change in installation with respect to previous issue.
	<b>SAFETY TORQUE:</b> This mark indicates that torque is related to safety.

## Procedure

---

Care must be taken when installing this accessory to ensure damage does not occur to the vehicle. The installation of this accessory should follow approved guidelines to ensure a quality installation.

These guidelines can be found in the "Accessory Installation Practices" document.

This document covers such items as:-

- Vehicle Protection (use of covers and blankets, cleaning chemicals, etc.).
- Safety (eye protection, rechecking torque procedure, etc.).
- Vehicle Disassembly/Reassembly (panel removal, part storage, etc.).
- Electrical Component Disassembly/Reassembly (battery disconnection, connector removal, etc.).

Please see your Scion dealer for a copy of this document.

### 1. Install the Owner's Portfolio.

(a) Remove the Owner's Portfolio from the polybag.

(b) Locate and open the glove compartment (Fig.1-1).

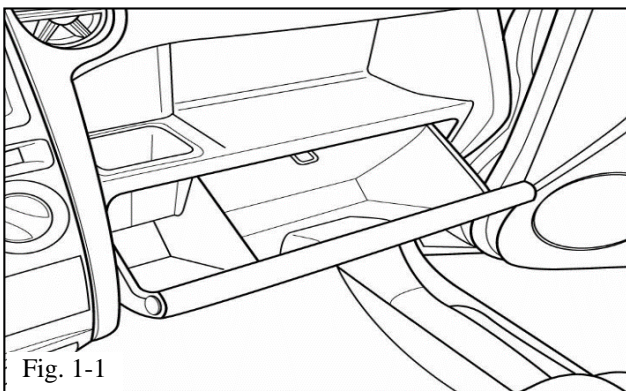

(c) Place the Owner's Portfolio in the glove compartment with the spine facing outward (Fig. 1-2).

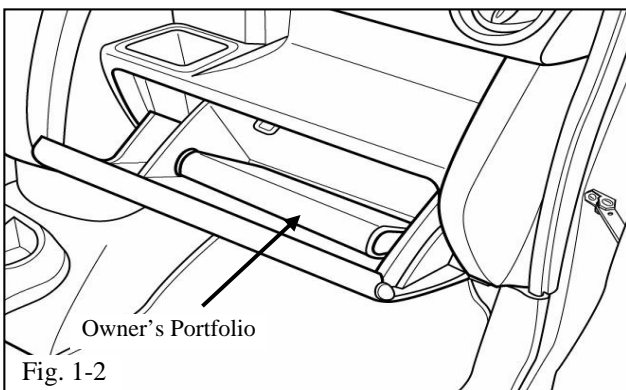

 (d) Close the glove compartment.

Checklist - these points **MUST** be checked to ensure a quality installation.

<u>Check:</u>	<u>Look For:</u>
<u>Accessory Function Checks</u>	
<input type="checkbox"/> Confirm proper placement of Owner's Portfolio.	Spine should be facing outward.
<input type="checkbox"/> Confirm glove compartment is closed	Glove compartment is securely closed.
<u>Vehicle Function Checks</u>	
<input type="checkbox"/>	
<u>Vehicle Appearance Checks</u>	
<input type="checkbox"/> Confirm proper placement of Owner's Portfolio.	Ensure no damage (including scuffs and scratches) was caused during the installation process.  (For PPO installations, refer to TMS Accessory Quality Shipping Standard.)